

d mm Wire diameter  
 D mm Mean coil diameter  
 Dd mm Diameter of mandrel  
 De mm Outer coil diameter  
 Dh mm Diameter of bush  
 e1 mm Perm.dev. perpendicular line  
 e2 mm Perm.dev. parallel line  
 F1 N Prestressed spring force  
 F2 N Loaded spring force

Fn N Maximum force in static use  
 Fc N Theoretic maximum force at Lc  
 L0 mm Length of unstressed spring  
 L1 mm Prestressed spring length  
 L2 mm Loaded spring length  
 Lk mm Buckling length  
 Ln mm Minimum length in static use  
 Lc mm Block length  
 n pc. Active coils

nt pc. Total coils  
 R N/mm Spring rate  
 S mm Pitch (distance between coils)  
 s1 mm Prestressed spring deflection  
 s2 mm Loaded spring deflection  
 sh mm Maximum stroke in static use  
 sn mm Maximum spring deflection in static use  
 Weight g Weight of one spring in grammes

Fndyn N Maximum force in dynamic force  
 Fndtol N (+/-) tolerance of maximum dynamic force  
 Lndyn mm Minimum length in dynamic use  
 shdyn mm Maximum stroke in dynamic use

\* The spring data for the dynamic applications is relevant only for springs having a shot peened hardened surface !

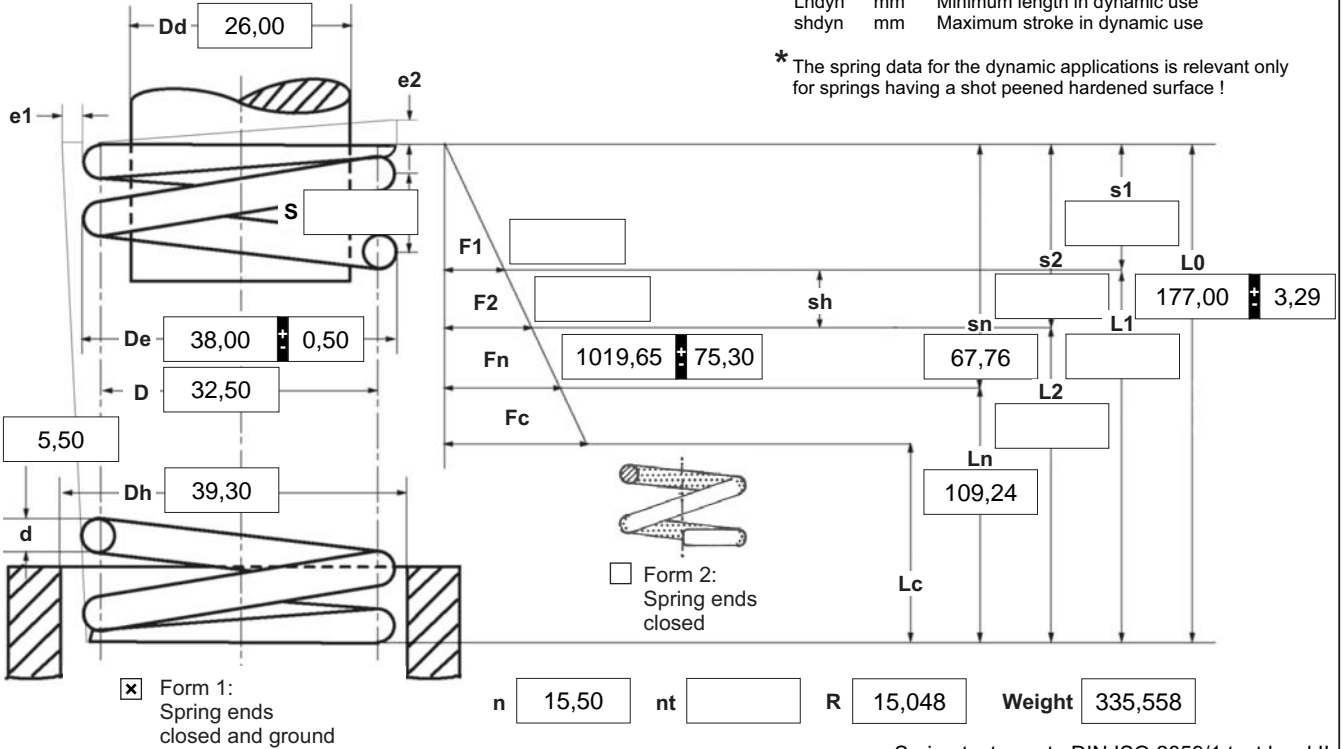

Spring test acc. to DIN ISO 2859/1 test level II

**1 Coiling direction**

left  right

**2 Dynamic load \***

Fndyn	921,84
Fndtol	73,60
Lndyn	115,74
shdyn	22,23

**3 Excursion sh**  mm

**4 Stress cyc. end. N**

**5 Stress cycle frequ. n**  /

**6 Application temp.**  °C

**Remarks**

País de origem: DE | Número de tarifa alfandegária: 73202081

**7 Guidance and seat to DIN EN 13906-1**

mandrel  bush

Buckling length **Lk** at   
 v=0,5 / Bild 5  68,40 mm

**8 Material**

EN 10270-3-1.4310

**9 Wire or rod surface**

drawn  rolled  metal-cut

**10 Springs deburred**  inside  outside

**11 Surface treatment**  shot peened

**12 Tolerances to DIN EN 15800**

Grade	De,Di,D	L0	F1,F2	e1,e2	Wire diameter d to DIN 2076
1	<input type="checkbox"/>	<input type="checkbox"/>	<input type="checkbox"/>	<input type="checkbox"/>	<input type="checkbox"/>
2	<input checked="" type="checkbox"/>	<input checked="" type="checkbox"/>	<input checked="" type="checkbox"/>	<input checked="" type="checkbox"/>	<input checked="" type="checkbox"/>
3	<input type="checkbox"/>	<input type="checkbox"/>	<input type="checkbox"/>	<input type="checkbox"/>	<input checked="" type="checkbox"/>

**13 Prouction compensation through**

A spring resistance and associated length of tensed spring	L0	<input type="checkbox"/>
A spring resistance, associated length of tensed spring and L0	n, d	<input checked="" type="checkbox"/>
	n, De, Di	<input type="checkbox"/>
Two spring resistances and associated lengths of tensed spring	L0, n, d	<input type="checkbox"/>
	L0,n,De,Di	<input type="checkbox"/>

**14 Setting springs**

All springs which show setting tendency because of their size are pre-set within the production process.

**Prices**

Desconto por quantidade	Preço individual [EUR]
1	
2	14,9000 €
3	11,8700 €
7	7,7300 €
17	5,7700 €
37	4,1600 €
75	3,5700 €
125	3,5200 €
175	3,5057 €
250	3,4790 €
350	3,4039 €
	3,3561 €