

d mm Wire diameter
 D mm Mean coil diameter
 Dd mm Diameter of mandrel
 De mm Outer coil diameter
 Dh mm Diameter of bush
 e1 mm Perm.dev. perpendicular line
 e2 mm Perm.dev. parallel line
 F1 N Prestressed spring force
 F2 N Loaded spring force

Fn N Maximum force in static use
 Fc N Theoretic maximum force at Lc
 L0 mm Length of unstressed spring
 L1 mm Prestressed spring length
 L2 mm Loaded spring length
 Lk mm Buckling length
 Ln mm Minimum length in static use
 Lc mm Block length
 n pc. Active coils

nt pc. Total coils
 R N/mm Spring rate
 S mm Pitch (distance between coils)
 s1 mm Prestressed spring deflection
 s2 mm Loaded spring deflection
 sh mm Maximum stroke in static use
 sn mm Maximum spring deflection in static use
 Weight g Weight of one spring in grammes
 Fndyn N Maximum force in dynamic force
 Fndtol N (+/-) tolerance of maximum dynamic force
 Lndyn mm Minimum length in dynamic use
 shdyn mm Maximum stroke in dynamic use

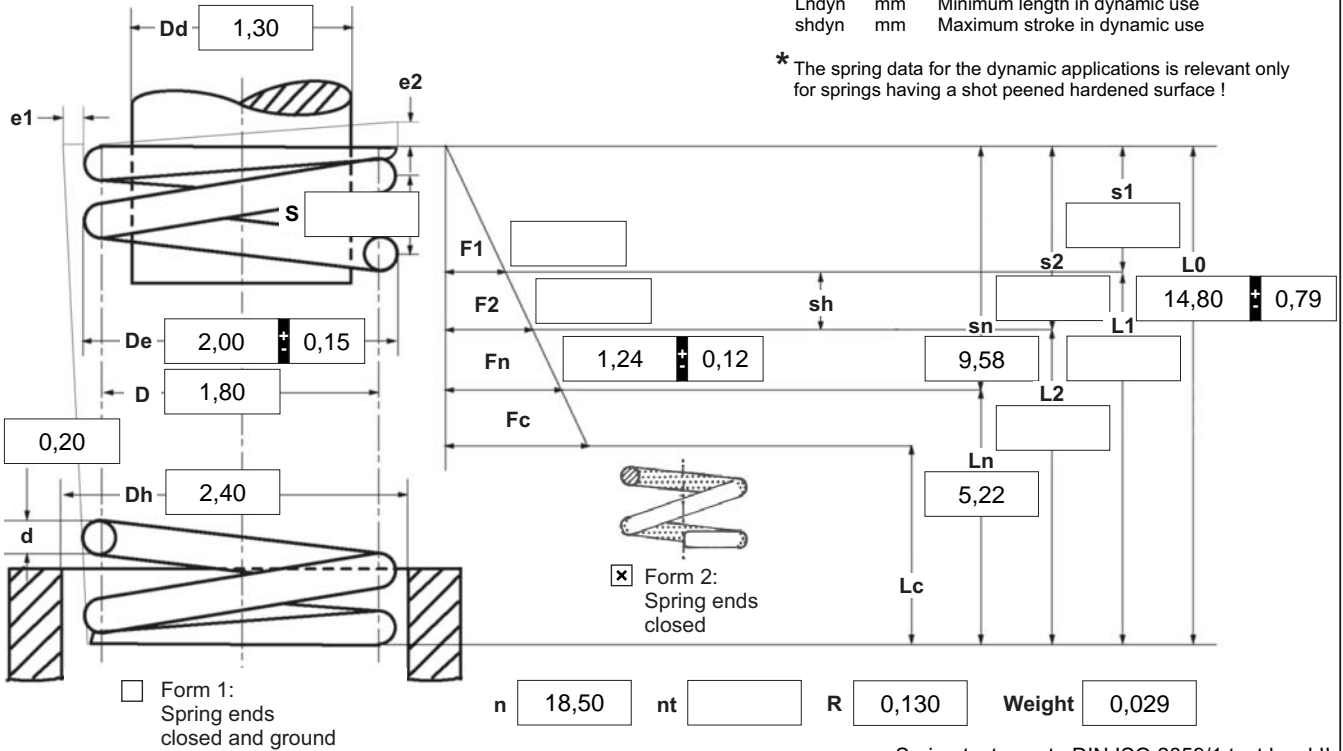

* The spring data for the dynamic applications is relevant only for springs having a shot peened hardened surface !

Spring test acc. to DIN ISO 2859/1 test level II

1 Coiling direction

left right

2 Dynamic load *

Fndyn	1,19
Fndtol	0,12
Lndyn	5,63
shdyn	3,85

3 Excursion sh mm

4 Stress cyc. end. N

5 Stress cycle frequ. n /

6 Application temp. °C

Remarks

País de origem: DE | Número de tarifa alfandegária: 73202081

7 Guidance and seat to DIN EN 13906-1

mandrel bush

Buckling length **Lk** at

v=0,5 / Bild 5 mm



8 Material

EN 10270-3-1.4310

9 Wire or rod surface

drawn rolled metal-cut

10 Springs deburred inside outside

11 Surface treatment shot peened

12 Tolerances to DIN EN 15800

Grade	De,Di,D	L0	F1,F2	e1,e2	Wire diameter d to DIN 2076
1	<input type="checkbox"/>	<input type="checkbox"/>	<input type="checkbox"/>	<input type="checkbox"/>	<input type="checkbox"/>
2	<input checked="" type="checkbox"/>	<input checked="" type="checkbox"/>	<input checked="" type="checkbox"/>	<input checked="" type="checkbox"/>	<input checked="" type="checkbox"/>
3	<input type="checkbox"/>	<input type="checkbox"/>	<input type="checkbox"/>	<input type="checkbox"/>	<input checked="" type="checkbox"/>

13 Prouction compensation through

A spring resistance and associated length of tensed spring	L0	<input type="checkbox"/>
A spring resistance, associated length of tensed spring and L0	n, d	<input checked="" type="checkbox"/>
	n, De, Di	<input type="checkbox"/>
Two spring resistances and associated lengths of tensed spring	L0, n, d	<input type="checkbox"/>
	L0,n,De,Di	<input type="checkbox"/>

14 Setting springs

All springs which show setting tendency because of their size are pre-set within the production process.

Prices

Desconto por quantidade	Preço individual [EUR]
1	
2	4,8500 €
3	3,4200 €
7	3,2600 €
17	1,8400 €
37	0,8300 €
75	0,5200 €
125	0,3400 €
175	0,2817 €
250	0,2192 €
350	0,1878 €
450	0,1452 €
	0,1264 €